

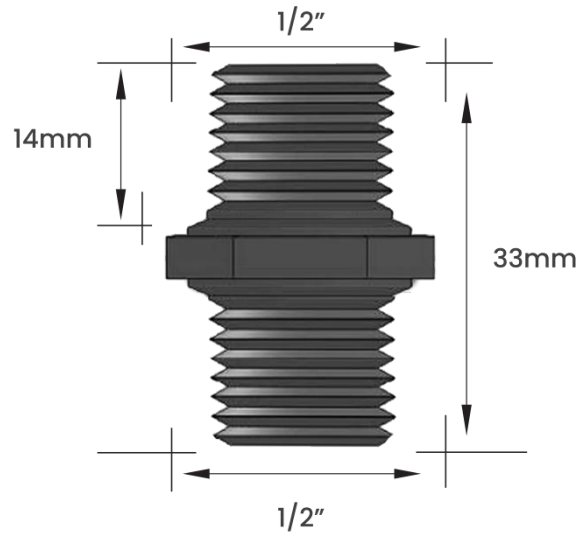

**DIMENSIONAL**



**FOTO**



**EMBALAGEM**



SACO PLÁSTICO INDIVIDUAL

CÓDIGO	ROSCA 1	ROSCA 2	PESO KG	MATERIAL	CÓD. BARRAS EAN 13	EMBALAGEM	CÓD. BARRAS EMB. MASTER - EAN 14	QUANT. EMB. MASTER
10603CRE	1/2"	1/2"	0,034	ZAMAC	7893308005814	Individual	17893308005811	100 peças

Obs:

Para uso em tanque ou máquina de lavar

Peso informado refere-se ao peso unitário de cada modelo de Niple

Nossos Niples são vendidos e faturados por peça

Final código "E" - mínimo de venda 1 peça